

Connector Specification

CBB410-NOTA

Board-to-board | 4PIN | 10mm Board width | NO Protection



【Features】

- Name: board-to-board connector
- PIN numbe:4PIN
- IP process:IP20
- Applicable board width:10 mm
- Rated current: AWG 22 / 4A Max
- Rated voltage:5V / 9V / 12V / 18V / 24V / 36V / 48V ;
- Voltage tolerance:500 V;
- Temperature tolerance:80 °C;
- Working temperature:- 20 °C ~ + 80 °C;
- Acceptable humidity:15% ~ 90%;
- 2-year warranty.
- Applicable product:5050 LED Strip: less than 60leds/m (include 60leds/m);



【Mechanical Parameter】

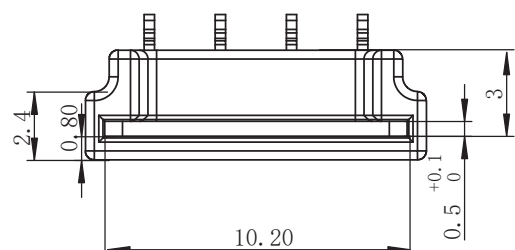
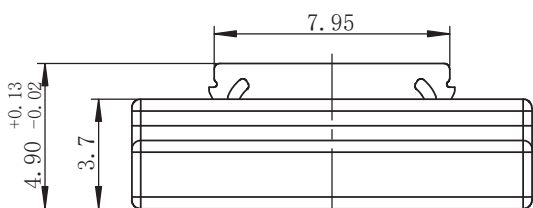
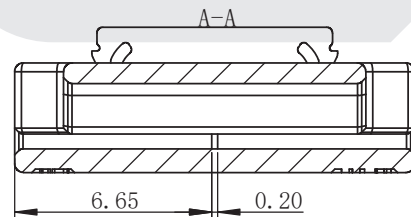
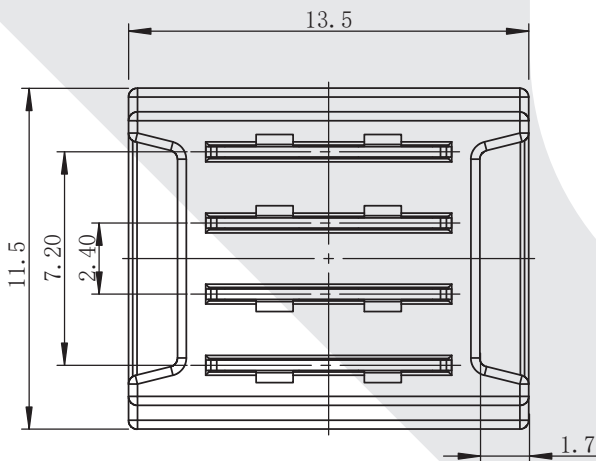

[Installation]

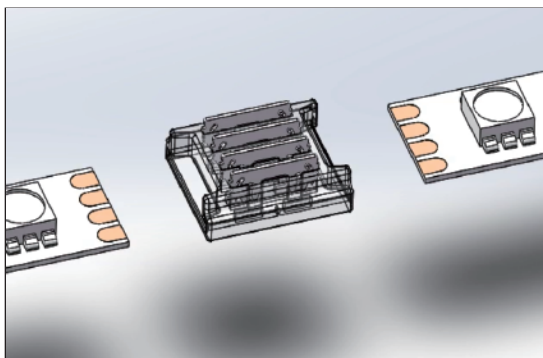

1. Prepare LED strip and matched connectors.

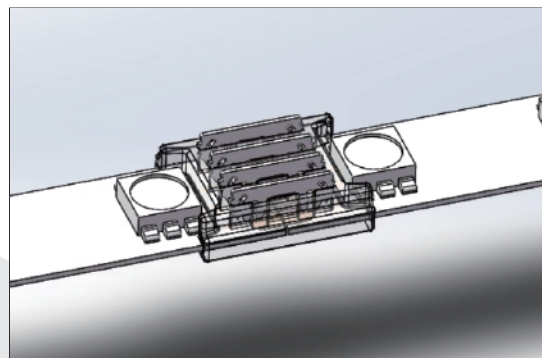

2. As diagram shows, insert connectors into place at two ends of LED strip and make sure the negative and positive poles of LED strip is connected correctly.

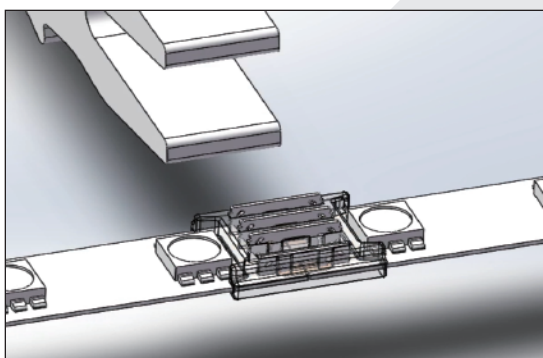

3. Use flat plier or other professional tool to press down the metal head of connector.

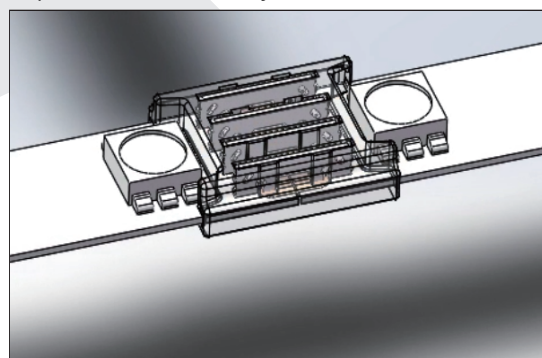

4. Connector installation finishes.

[Product package]

· Standard package information (10pcs/bag)

1. 10pcs connectors packed into PE bag



2. 5 PE bags packed into box

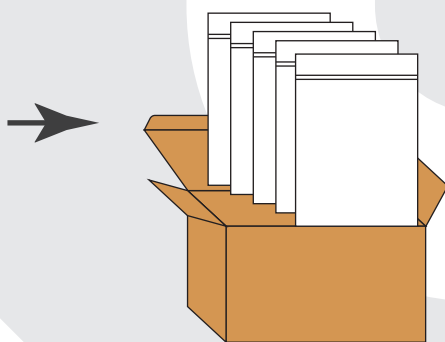

3. Stick information label onto the box



Product code	Net weight per piece	Weight of per bag	Weight of per box	Weight of per carton
CBB410-NOTA	0.62g	7.65g	59.5g	3.79kg

Note: weight error is within 10%

[Precaution]

- Please use this product in dry environment.
- Before installation, pay attention to negative and positive poles of LED strip to avoid short circuit or product damage
- Use professional tools as per requirements to press down metal head of connector to avoid hurt or fingers or product damage.